

PRELIMINARY

Power Ring Film Capacitor™
100 μ F, 3500 Vdc

Electrical Specifications

SBE Part #: 774D103

Capacitance/Tolerance: 100 μ F \pm 10%

DC Voltage Rating: 3500 Vdc

Dielectric/Construction: Metallized Polypropylene film.

Dielectric Withstand Voltage: Units 100% tested at DC potential of 4000 Volts for two minutes at 25°C.

Peak-to-Peak Voltage: 3,500

ESR @ 10 kHz: < 1.7 milliohm at +25°C, typical

ESL: > 50nH

Operating Temperature: -10°C to +75°C

Peak Current Rating: 10,000 Amps Repetitive



Mechanical Specifications

Core:	Hollow phenolic core with 2.0" I.D.	Marking: APCS	APCS company identification
Terminals:	Tin plated copper strap, 0.062" thick by 2.5" wide.	774D103	APCS "short form" part number
Encapsulation:	Black outer tape wrap and white epoxy potting.	100 μ F \pm 10%	Capacitance value and Tolerance
Mechanical Mounting:	If possible, mounting of this unit using the core will help to provide stress relief for the terminals.	3500 Vdc	DC voltage rating
		yyww-lot#-unit	Serial number (date code, lot number, unit number)

Layout Details:

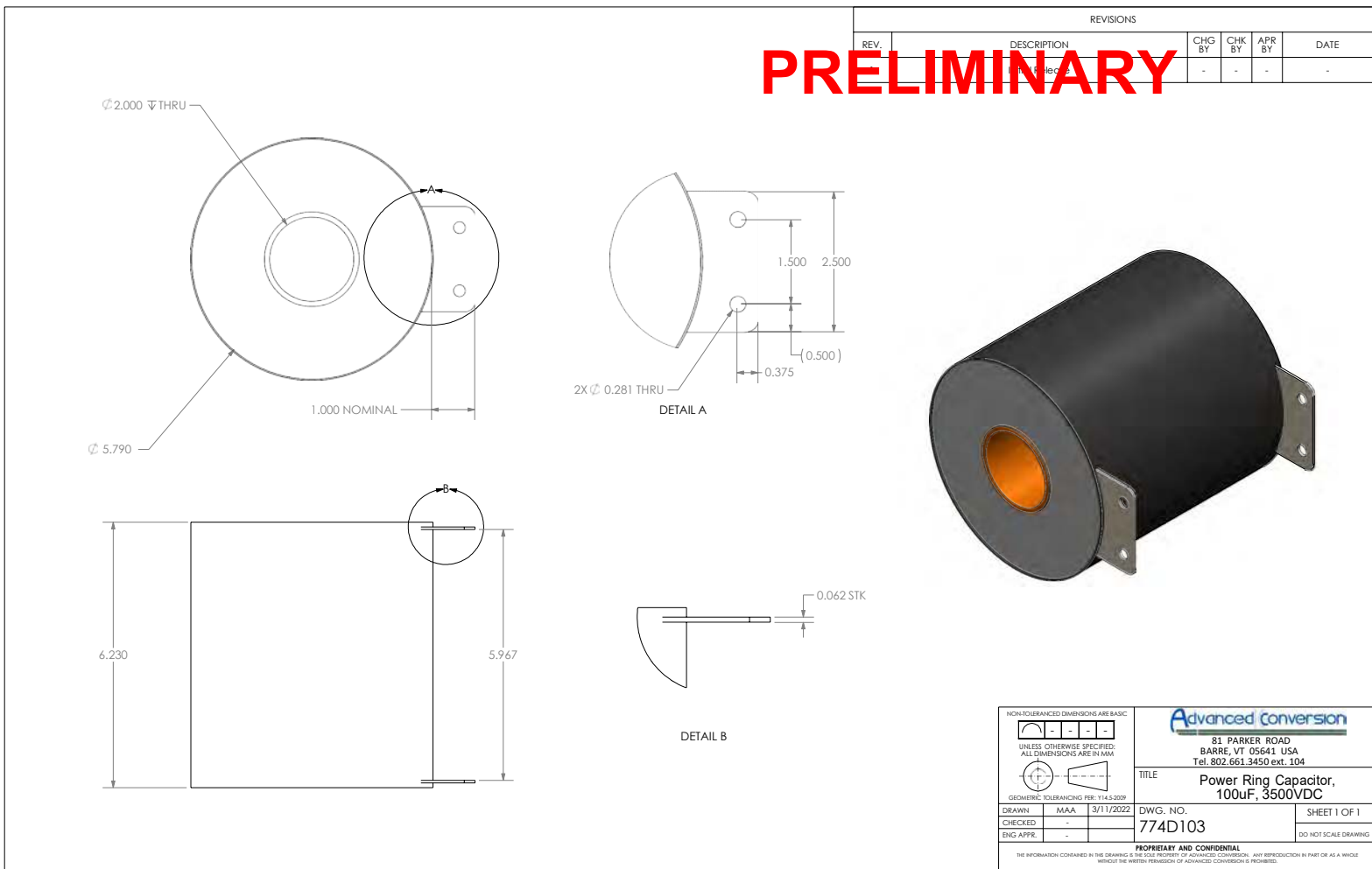

Rev 1 3/11/22

Advanced Conversion
 81 Parker Road • Barre, VT 05641 USA
 Tel: 802-661-3450
 Web: www.advanced-conversion.com