

Data Sheet

GU-LCT-RY-V1-10

Part No.: AA-10276-001

Optical Input / Output: Glass Fibre

GU-LCT-RY-V1-11

Part No.: AA-10276-002

Optical Input / Output: Plastic (POF)



Picture shows AA-10276-001 (Glass Fibre)

Trigger Generator

Features

- For Series Connected Thyristors
- For Simultaneous Triggering
- Compact Design
- Immune to external EM Fields
- Optical Trigger Input Glass Fibre or Plastic (POF)
- Optical Status Feedback Glass Fibre or Plastic (POF)

Rev.	Remarks / changes	created		checked		released	
13	Initial, created from 5SYA1712-01	FF	14.08.12	AST	15.8.12	FF	15.8.12
14	Added input voltage range	AST	15.02.13	FF	15.02.13	AST	15.02.13
15	Added more information on paragraph 3.3ff	AST	03.04.13	FF	04.04.13	AST	04.04.13

Table of Contents

1.	Introduction	3
1.1.	Description	3
1.2.	Electrical interfaces	3
1.3.	Optical interfaces	3
1.3.1.	Optical Control Signal (CS)	3
1.3.2.	Optical Status Feedback (SF1, SF2)	3
1.4.	Environmental conditions	4
2.	Connectors and indicators	4
2.1.	Connectors (POF model)	4
2.2.	Connectors (ST model)	4
2.3.	Terminal Block 	4
2.4.	Indicators	4
3.	Function	5
3.1.	Instructions for use	5
3.2.	Block diagram	5
3.3.	Power supply and optical IO	5
3.4.	Timing diagrams	6
3.4.1.	Trigger pulse < 780ns	6
3.4.2.	780ns < Trigger pulse < 7ms	6
3.4.3.	Trigger pulse > 7ms	7
3.4.4.	SF2 inactive (no light)	7
4.	Mechanical	8
4.1.	Parameters	8
4.2.	Mechanical Drawing	8
4.3.	Labels	9
4.3.1.	Front side	9
4.3.2.	Rear side	9
4.3.3.	Bottom side	9
4.3.4.	Top side	9
5.	Order code	9

1. Introduction

1.1. Description

The Trigger Generator AA-10276-002 is used to generate a turn-on gate pulse for series connected thyristors. An inductive coupling using a high voltage isolated closed loop cable ensures the triggering of the thyristors at different potential levels. See also Order code.

1.2. Electrical interfaces

Parameter	Symbol	Condition	Min	Typ	Max	Unit
Auxiliary power	V_{Sup_aux}	AC, f=50/60Hz	34	40	46	VAC
	V_{Sup_aux}	DC	26	28	56	VDC
Auxiliary power consumption	P	Depends on repetition rate f	15	-	40	W
Trigger repetition rate	F	-	-	-	60	Hz
Delay time	Td	-	-	1.2	-	µs
Max number of connected Thyristors	N	-	-	-	24	Pcs

1.3. Optical interfaces

1.3.1. Optical Control Signal (CS)

AA-10276-001 GU-LCT-RY-V1-10 Glass Fibre

Parameter	Symbol	Condition	Min	Typ	Max	Unit
Control signal CS power hi	P_{Inp_high}	HFBR-2412	-9.2	-	-	dBm
Control signal CS power lo	P_{Inp_low}	HFBR-2412	-	-	-40	dBm

AA-10276-002 GU-LCT-RY-V1-11 Plastic (POF)

Parameter	Symbol	Condition	Min	Typ	Max	Unit
Control signal CS power hi	P_{Inp_high}	HFBR-2528 (Avago)	-20	-	-	dBm
Control signal CS power lo	P_{Inp_low}	HFBR-2528 (Avago)	-	-	-42	dBm

1.3.2. Optical Status Feedback (SF1, SF2)

AA-10276-001 GU-LCT-RY-V1-10 Glass Fibre

Parameter	Symbol	Condition	Min	Typ	Max	Unit
Optical feedback SFx power hi ¹⁾	P_{Out_high}	HFBR-1414	-10	-	-	dBm
Optical feedback SFx power lo ¹⁾	P_{Out_low}	HFBR-1414	-	-	-40	dBm

AA-10276-002 GU-LCT-RY-V1-11 Plastic (POF)

Parameter	Symbol	Condition	Min	Typ	Max	Unit
Optical feedback SFx power hi ¹⁾	P_{Out_high}	HFBR-1528 (Avago)	-20	-	-	dBm
Optical feedback SFx power lo ¹⁾	P_{Out_low}	HFBR-1528 (Avago)	-	-	-40	dBm

1) For 1m optical cable

1.4. Environmental conditions

Parameter	Symbol	Condition	Min	Typ	Max	Unit
Ambient temperature	T _{amb}	-	-25	-	+85	°C
Storage temperature	T _{store}	-	-40	-	+85	°C
Humidity	Hum	Non condensing	-	-	95	% RH
Operating altitude	Alt	-			3000	m

2. Connectors and indicators



The Trigger Generator GU-LCT-RY-V1X has a dangerous output voltage of 300V.
 - Do not open the Trigger Generator housing when it is powered
 - No wiring to be done when the Trigger Generator is powered

2.1. Connectors (POF model)

Parameter	Symbol	Description
Auxiliary power	40VAC	-
Optical control signal	CS	HFBR-2528 (Avago) /
Plug type on optical cable customer side	CS	HFBR-4532 (Avago)
Optical status feedback transmitter	SF1, SF2	HFBR-1528 (Avago)
Plug type on optical cable customer side	SF1, SF2	HFBR-4532 (Avago)

2.2. Connectors (ST model)

Parameter	Symbol	Description
Auxiliary power	40VAC	-
Optical control signal	CS	HFBR-2412 (Avago) /
Plug type on optical cable customer side	CS	01-H200/VJZ-D26
Optical status feedback transmitter	SF1, SF2	HFBR-1414 (Avago)
Plug type on optical cable customer side	SF1, SF2	01-H200/VJZ-D26

2.3. Terminal Block

Parameter	Symbol	Description
Electrical output	1,2	1 is near GND / 2 on potential (~300V)

2.4. Indicators

Parameter	Symbol	Description
LED (yellow)	CS_LED	Lit when CS is P _{INP_High} Dark when CS is P _{INP_Low}
LED (green)	SF2_LED	Lit when the trigger generator is ready Dark when the trigger generator is not ready

3. Function

3.1. Instructions for use

- Make sure that the device works correctly before using in a critical application.
- Consult the according datasheet for the correct optical power for the application you want to operate with this device

3.2. Block diagram

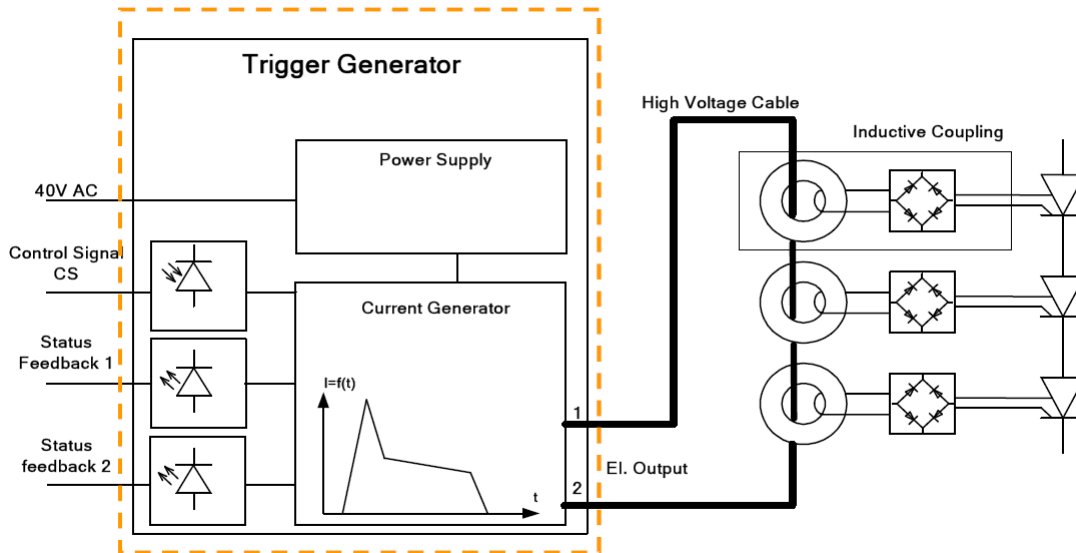

Inductive couplings and HV cable do not belong to scope of supply. To be ordered separately..

3.3. Power supply and optical IO

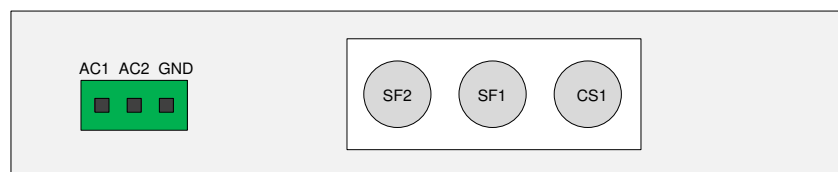

3.4. Timing diagrams

- Control signal = Trigger input from external source
- SF1 = Status feedback 1
- SF2 = Status feedback 2
- Electrical out = Current output to inductive coupling

3.4.1. Trigger pulse < 780ns

If the pulse on the control signal input has duration of less than 780ns no output pulse will be generated.

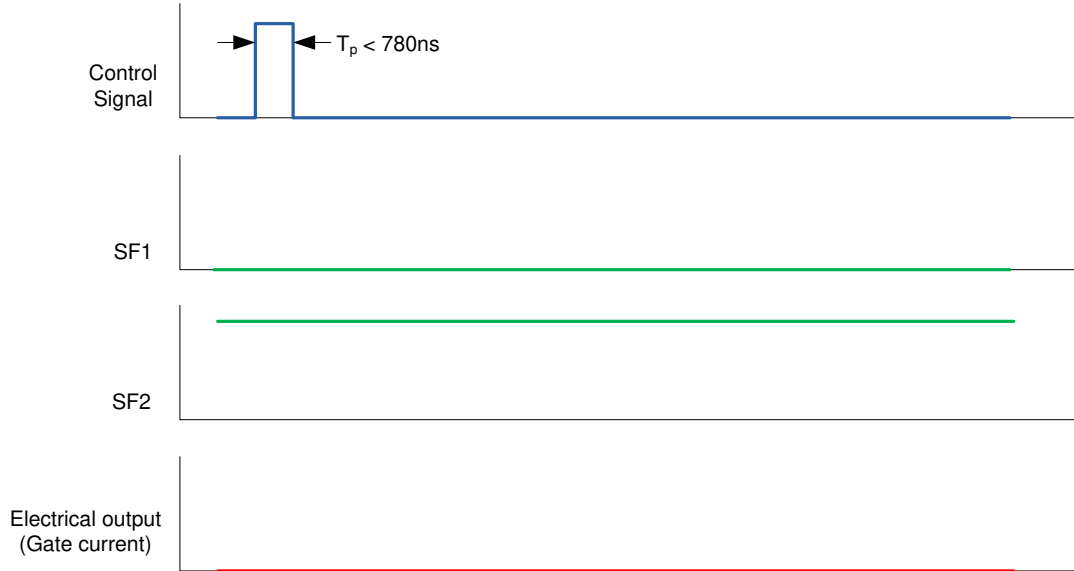

Fig. 1: Trigger pulse < 780ns

3.4.2. 780ns < Trigger pulse < 7ms

If the pulse duration lies between the minimum acceptable duration and 7ms the following output is generated.

- SF1 shows the active period of the GU-LCT
- SF2 shows the vital state of the Gateunit. Check before triggering. If there is no light the GU-LCT has a major problem and triggering is NOT allowed. See also 3.4.4.

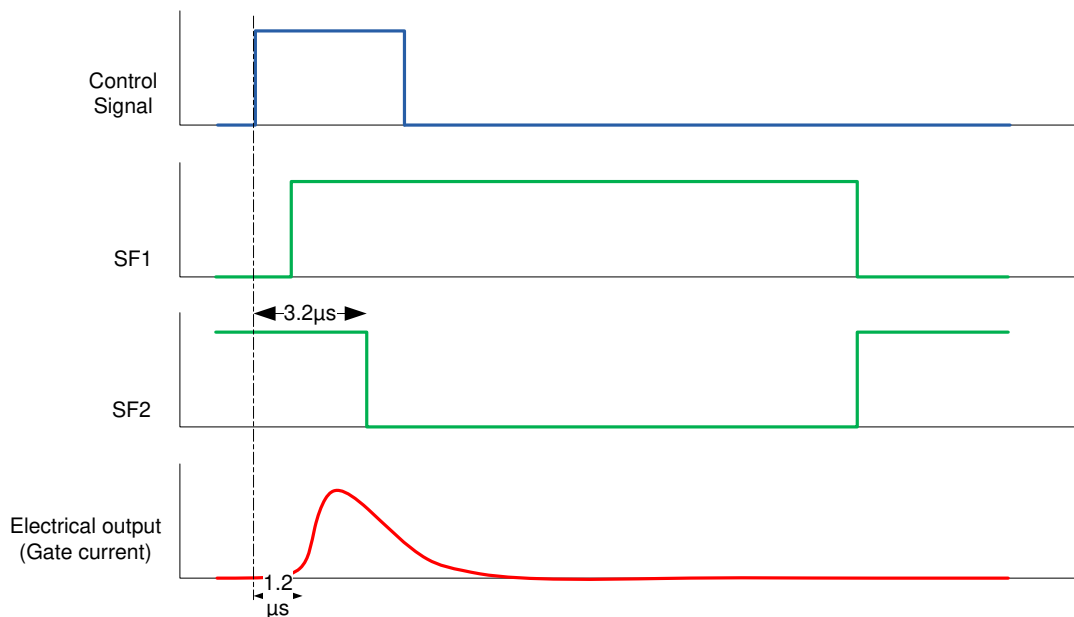

Fig. 2: 780ns < Trigger pulse < 7ms

3.4.3. Trigger pulse > 7ms

If the trigger pulse lasts longer than 7ms on the opto input there will be a post trigger every 7ms as long as the trigger input sees light (is in the On State).

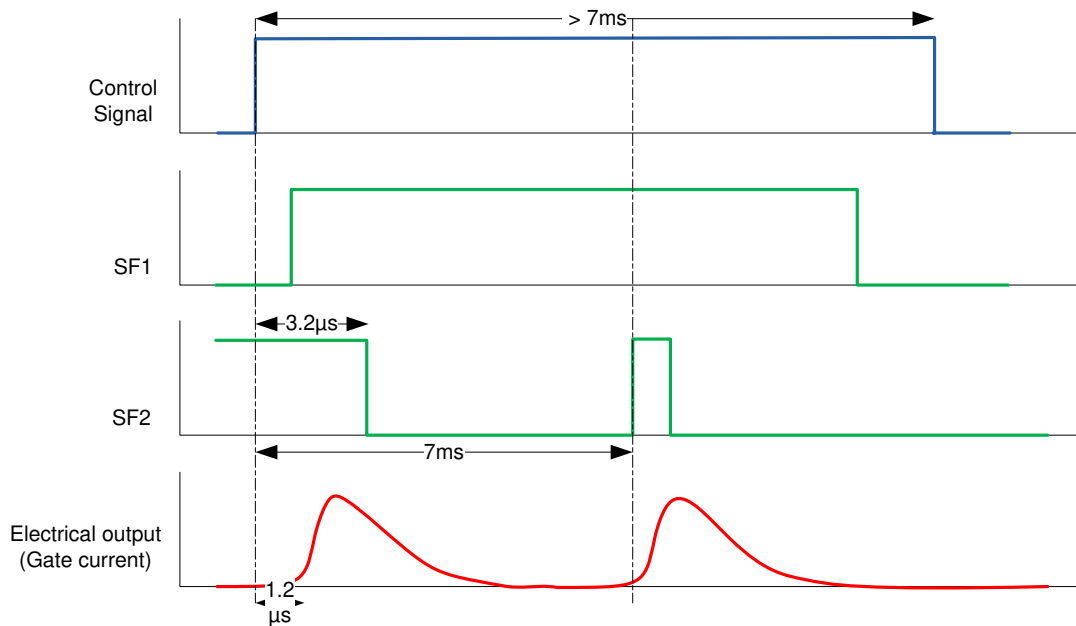
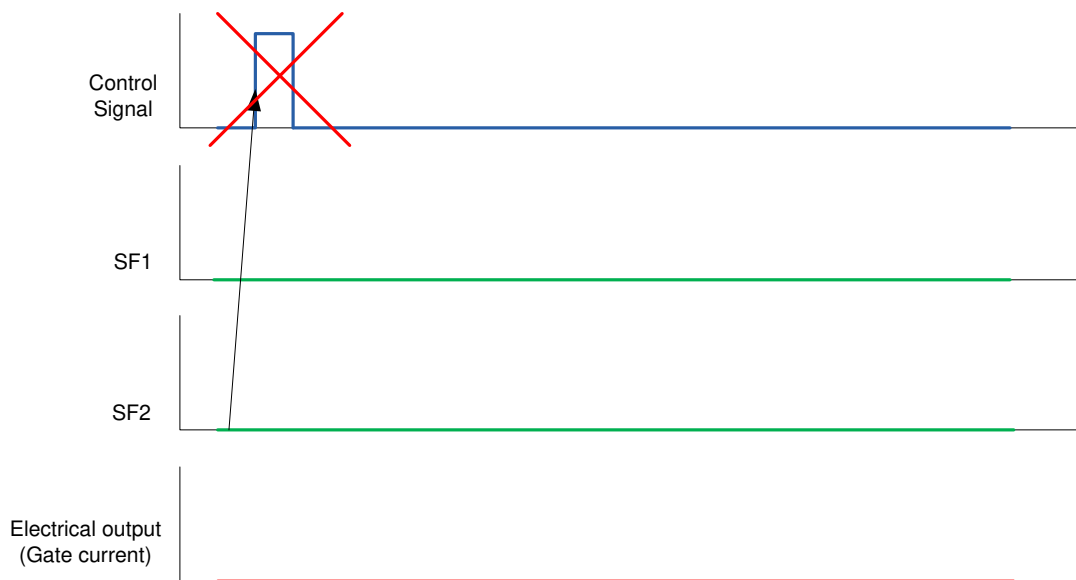

Fig. 3: Trigger pulse > 7ms

3.4.4. SF2 inactive (no light)

If SF2 is inactive (no light) there is a major problem in the GU-LCT (eg. Pulse voltage Generator, power supply or logic defective). If so, triggering in this state is prohibited.



4. Mechanical

4.1. Parameters

Parameter	Symbol	Condition	Min	Typ	Max	Unit
Weight	m	-		0.9		kg
Dimensions	WxDxH	-		(184 x 152 x 40)		mm

4.2. Mechanical Drawing

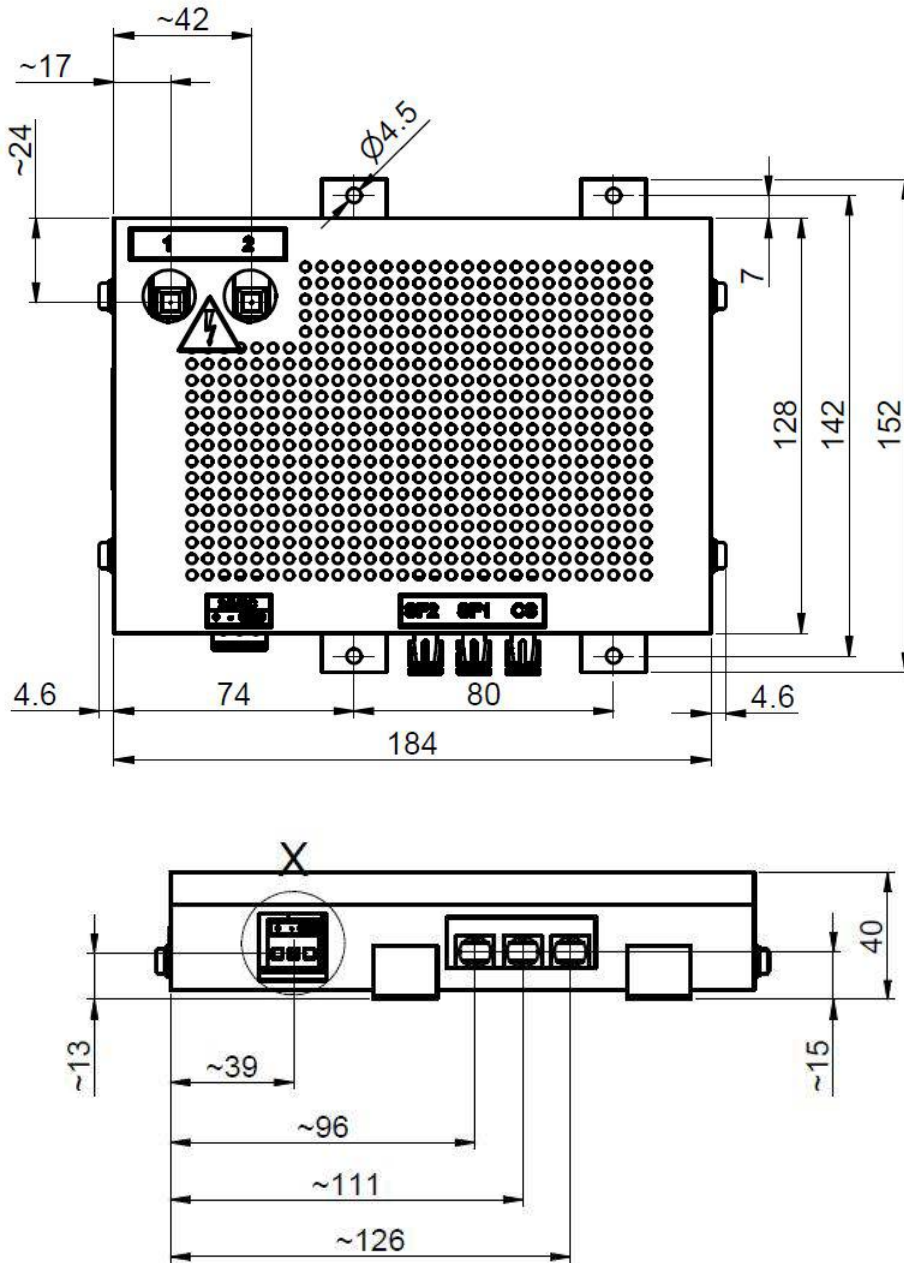



4.3. Labels

4.3.1. Front side

- Nothing

4.3.2. Rear side

- Nothing

4.3.3. Bottom side

- Type label with serial number

4.3.4. Top side

- Terminal (1, 2)
- CS
- SF1, SF2
- Aux. power

5. Order code

AA-10276-001

GU-LCT-RY-V1-10 Optical Input / Output Glass Fibre

AA-10276-002

GU-LCT-RY-V1-11 Optical Input / Output Plastic (POF)

Astrol Electronic AG
Gewerbehäus Casora
5452 Oberrohrdorf
Switzerland

Phone: +41 (0) 56 485 60 20

Fax: +41 (0) 56 496 62 51

e-mail: info@astrol.ch

web: www.astrol.ch