



## Data Sheet

# GU-LCT-RY-V2-2x

Part No.: AA-10355-00x

Optical Input / Output: Glass Fiber or plastic (POF)



Picture shows AA-10355-001 (Glass Fibre)

## Trigger Generator

### Features

- For Series Connected Thyristors
- For Simultaneous Triggering
- Back porch
- Compact Design
- Immune to external EM Fields
- Optical Trigger Input Glass Fiber or Plastic (POF)
- Optical Status Feedback Glass Fiber or Plastic (POF)

Rev.	Remarks / changes	created		checked		released	
		AST	10.10.13	FF	17.10.13	AST	17.10.13
01	Initial						

## Table of Contents

1.	Introduction .....	3
1.1.	Description .....	3
1.2.	Electrical interfaces .....	3
1.3.	Optical interfaces .....	3
1.3.1.	Optical Control Signal (CS) .....	3
1.3.2.	Optical Status Feedback (SF1, SF2) .....	3
1.4.	Environmental conditions .....	4
2.	Connectors and indicators .....	4
2.1.	Connectors (POF model) .....	4
2.2.	Connectors (ST model) .....	4
2.3.	Terminal Block  .....	4
2.4.	Indicators .....	4
3.	Function .....	5
3.1.	Instructions for use .....	5
3.2.	Block diagram .....	5
3.3.	Power supply and optical IO .....	5
3.4.	Timing diagrams .....	6
3.4.1.	Trigger pulse < 780ns .....	6
3.4.2.	780ns < Trigger pulse < infinite time .....	6
3.4.3.	SF2 inactive (no light) .....	7
4.	Mechanical .....	8
4.1.	Parameters .....	8
4.2.	Mechanical Drawing .....	8
4.3.	Labels .....	9
4.3.1.	Front side .....	9
4.3.2.	Rear side .....	9
4.3.3.	Bottom side .....	9
4.3.4.	Top side .....	9
5.	Order code .....	9

## 1. Introduction

### 1.1. Description

The Trigger Generator AA-10355-001 is used to generate a turn-on gate pulse for series connected Thyristors. An inductive coupling using a high voltage isolated closed loop cable ensures the triggering of the Thyristors at different potential levels. See also Order code.

### 1.2. Electrical interfaces

Parameter	Symbol	Condition	Min	Typ	Max	Unit
Auxiliary power	V <sub>Sup_aux</sub>	AC, f=50/60Hz	18	40	48	VAC
	V <sub>Sup_aux</sub>	DC	26	28	72	VDC
Auxiliary power consumption	P	Depends on repetition rate f	15	-	40	W
Trigger repetition rate	F	-	-	-	60	Hz
Delay time	T <sub>d</sub>	-	-	1.2	-	µs
Max number of connected Thyristors	N	-	-	-	24	pcs <sup>1)</sup>

<sup>1)</sup> contact factory for more information

### 1.3. Optical interfaces

#### 1.3.1. Optical Control Signal (CS)

##### AA-10355-001 GU-LCT-RY-V2-20 Glass Fibre

Parameter	Symbol	Condition	Min	Typ	Max	Unit
Control signal CS power hi	P <sub>Inp_high</sub>	HFBR-2412	-9.2	-	-	dBm
Control signal CS power lo	P <sub>Inp_low</sub>	HFBR-2412	-	-	-40	dBm

##### AA-10355-002 GU-LCT-RY-V2-21 Plastic (POF)

Parameter	Symbol	Condition	Min	Typ	Max	Unit
Control signal CS power hi	P <sub>Inp_high</sub>	HFBR-2528 (Avago)	-20	-	-	dBm
Control signal CS power lo	P <sub>Inp_low</sub>	HFBR-2528 (Avago)	-	-	-42	dBm

#### 1.3.2. Optical Status Feedback (SF1, SF2)

##### AA-10355-001 GU-LCT-RY-V2-20 Glass Fibre

Parameter	Symbol	Condition	Min	Typ	Max	Unit
Optical feedback SFx power hi <sup>1)</sup>	P <sub>Out_high</sub>	HFBR-1414	-10	-	-	dBm
Optical feedback SFx power lo <sup>1)</sup>	P <sub>Out_low</sub>	HFBR-1414	-	-	-40	dBm

##### AA-10355-002 GU-LCT-RY-V2-21 Plastic (POF)

Parameter	Symbol	Condition	Min	Typ	Max	Unit
Optical feedback SFx power hi <sup>1)</sup>	P <sub>Out_high</sub>	HFBR-1528 (Avago)	-20	-	-	dBm
Optical feedback SFx power lo <sup>1)</sup>	P <sub>Out_low</sub>	HFBR-1528 (Avago)	-	-	-40	dBm

<sup>1)</sup> For 1m optical cable

## 1.4.Environmental conditions

Parameter	Symbol	Condition	Min	Typ	Max	Unit
Ambient temperature	T <sub>amb</sub>	-	-25	-	+60	°C
Storage temperature	T <sub>store</sub>	-	-25	-	+85	°C
Humidity	Hum	Non condensing	-	-	95	% RH
Operating altitude	Alt	-			3000	m

## 2. Connectors and indicators



The Trigger Generator GU-LCT-RY-Vxxx has a dangerous output voltage of 300V.  
 - Do not open the Trigger Generator housing when it is powered  
 - No wiring to be done when the Trigger Generator is powered

### 2.1.Connectors (POF model)

Parameter	Symbol	Description
Optical control signal	CS	HFBR-2528 (Avago) /
Plug type on optical cable customer side	CS	HFBR-4532 (Avago)
Optical status feedback transmitter	SF1, SF2	HFBR-1528 (Avago)
Plug type on optical cable customer side	SF1, SF2	HFBR-4532 (Avago)

### 2.2.Connectors (ST model)

Parameter	Symbol	Description
Optical control signal	CS	HFBR-2412 (Avago) /
Plug type on optical cable customer side	CS	01-H200/VJZ-D26
Optical status feedback transmitter	SF1, SF2	HFBR-1414 (Avago)
Plug type on optical cable customer side	SF1, SF2	01-H200/VJZ-D26

### 2.3.Terminal Block

Parameter	Symbol	Description
Electrical output	1,2	1 is near GND / 2 on potential (~300V)

### 2.4.Indicators

Parameter	Symbol	Description
LED (yellow)	CS_LED	Lit when CS is P <sub>INP_High</sub> Dark when CS is P <sub>INP_Low</sub>
LED (green)	SF2_LED	Lit when the trigger generator is ready Dark when the trigger generator is not ready

## 3. Function

### 3.1. Instructions for use

- Make sure that the device works correctly before using in a critical application.
- Consult the according datasheet for the correct optical power for the application you want to operate with this device

### 3.2. Block diagram

This block diagram shows the normal usage of the GU-LCT-RY-V2-2x with several Gate drive units in series.

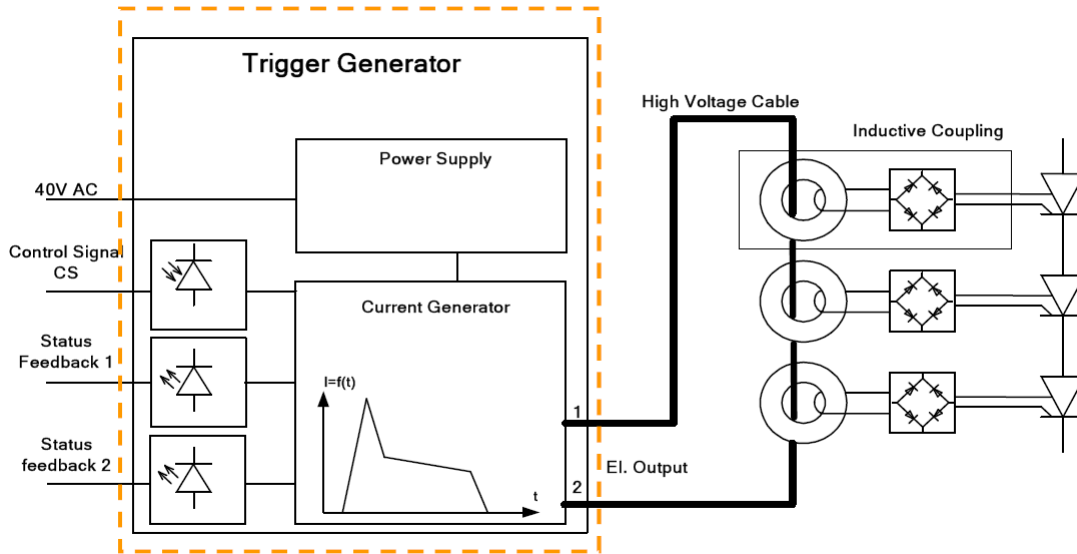

Inductive couplings and HV cable do not belong to scope of supply. To be ordered separately.

### 3.3. Power supply and optical IO

Input AC1 or AC2. GND must be wired to the protective earth. If DC input is used, connect PLUS to AC1, MINUS to AC2 and GND also to protective EARTH.

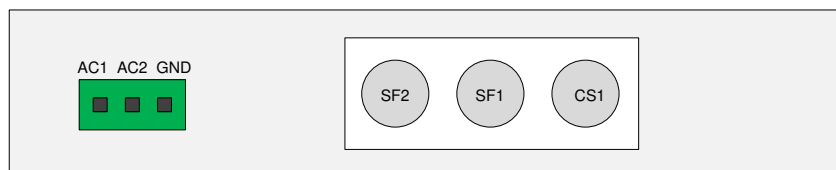

## 3.4. Timing diagrams

- Control signal = Trigger input from external source
- SF1 = Status feedback 1
- SF2 = Status feedback 2
- Electrical out = Current output to inductive coupling

### 3.4.1. Trigger pulse < 780ns

If the pulse on the control signal input has duration of less than 780ns no output pulse will be generated.

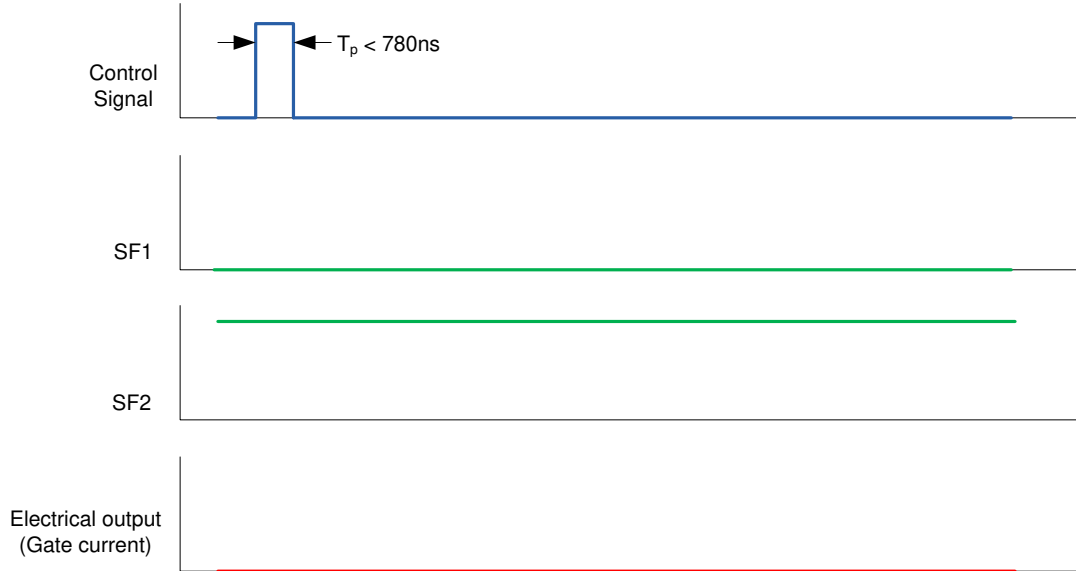

Fig. 1: Trigger pulse < 780ns

### 3.4.2. 780ns < Trigger pulse < infinite time

If the pulse duration lies between the minimum acceptable duration and endless time, the following output is generated. As soon as the main pulse is finished the Gate Drive Unit will start with generating the back porch.

- SF1 shows the active period of the GU-LCT
- SF2 shows the vital state of the Gateunit. Check before trigger. If there is no light the GU-LCT has a major problem and triggering is NOT allowed. See also 3.4.3.

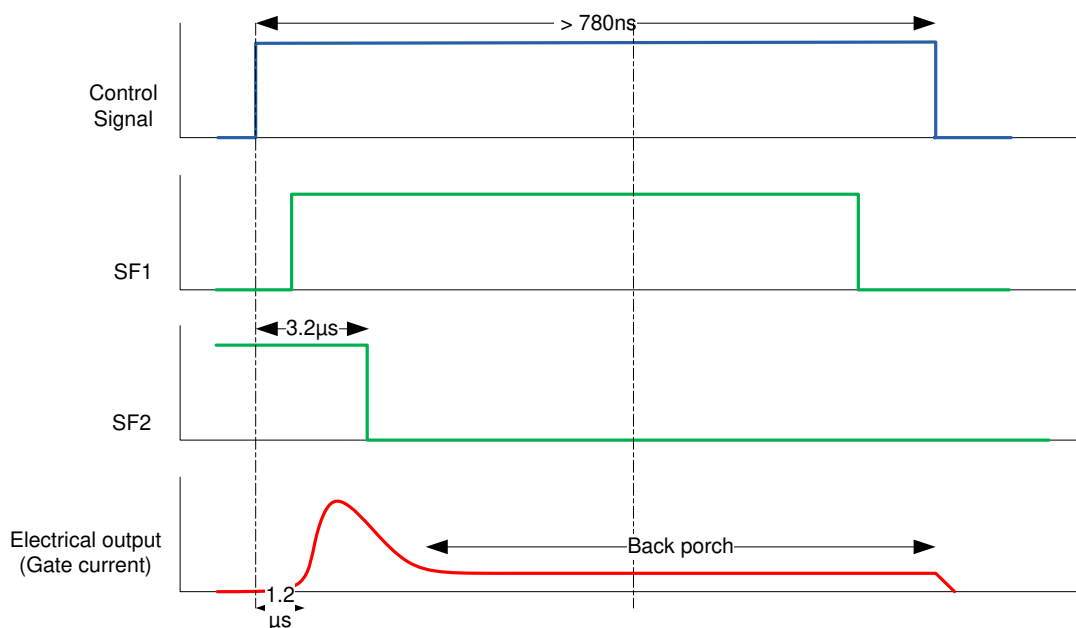
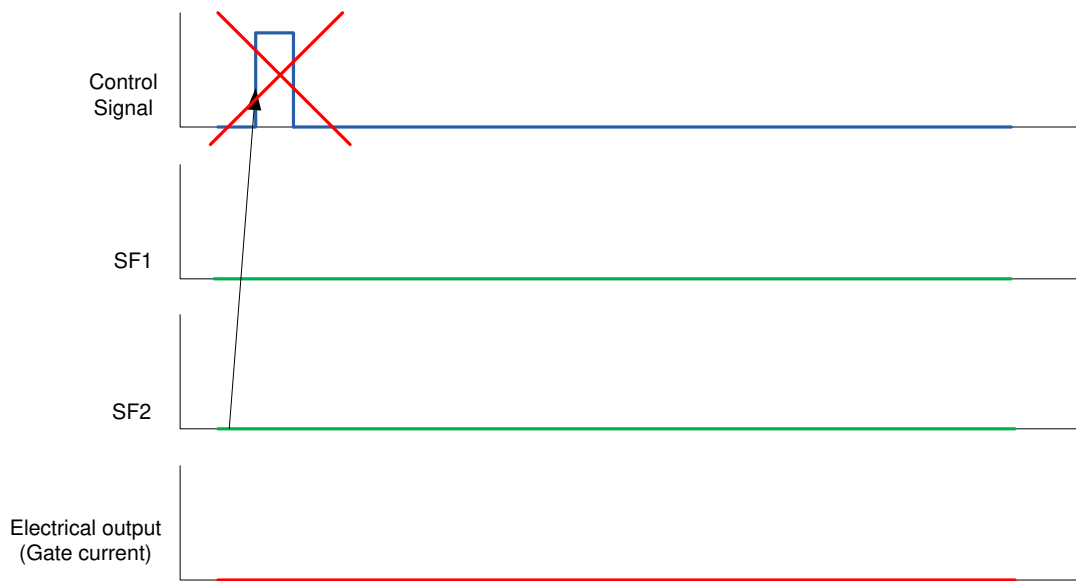

Fig. 2: 780ns < Trigger pulse < infinite time



### 3.4.3. SF2 inactive (no light)

If SF2 is inactive (no light) there is a major problem in the GU-LCT (eg. Pulse voltage Generator, power supply or logic defective). If so, triggering in this state is prohibited.



## 4. Mechanical

### 4.1. Parameters

Parameter	Symbol	Condition	Min	Typ	Max	Unit
Weight	m	-		0.9		kg
Dimensions	WxDxH	-		(174.5 x 183 x 40)		mm

### 4.2. Mechanical Drawing

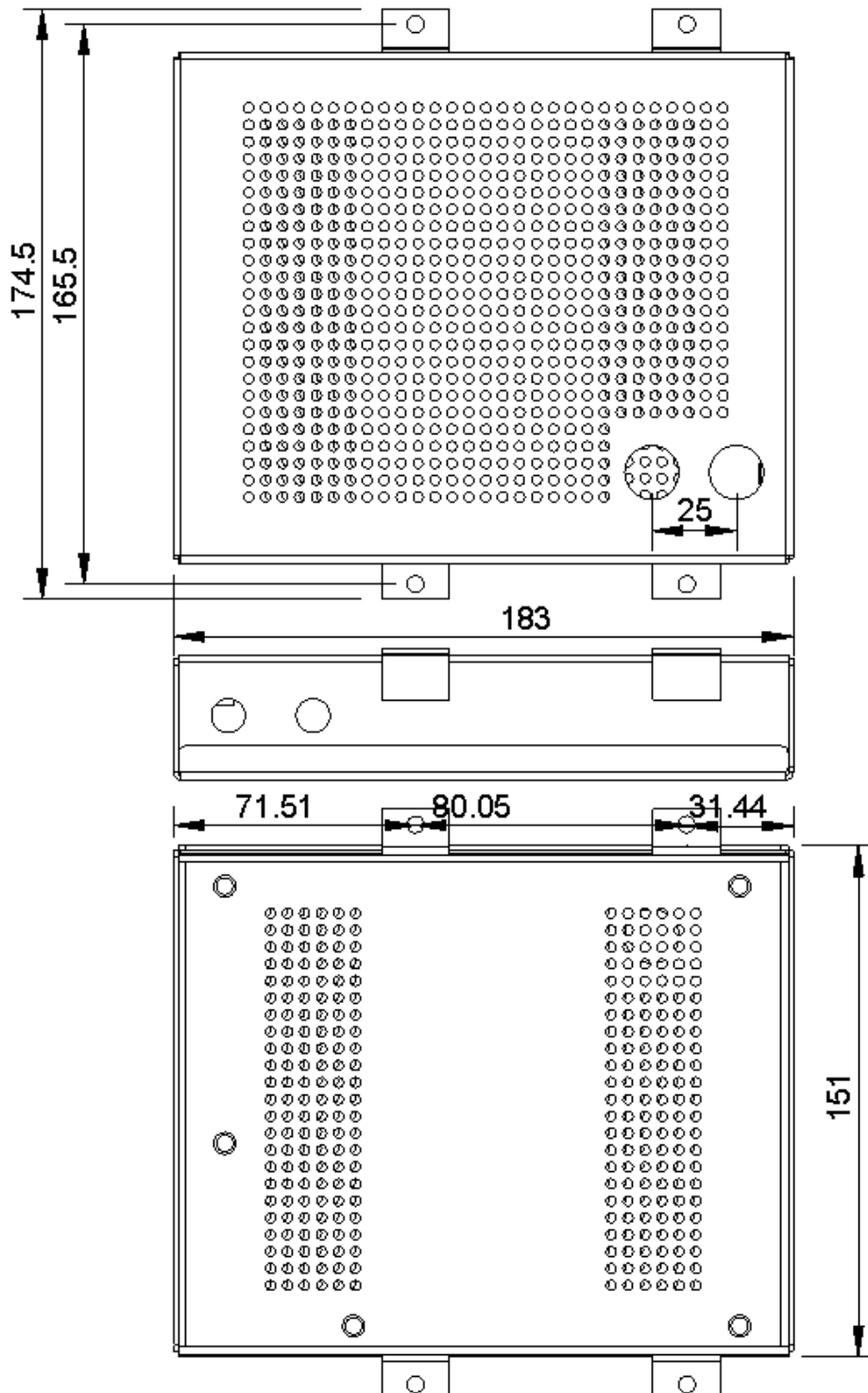





## 4.3. Labels

### 4.3.1. Front side

- Nothing

### 4.3.2. Rear side

- Nothing

### 4.3.3. Bottom side

- Type label with serial number

### 4.3.4. Top side

- Terminal (1, 2)
- CS
- SF1, SF2
- Aux. power

## 5. Order code

AA-10355-001

GU-LCT-RY-V2-20 Optical Input / Output Glass Fiber

AA-10355-002

GU-LCT-RY-V2-21 Optical Input / Output POF

Astrol Electronic AG  
Gewerbehäus Casora  
5452 Oberrohrdorf  
Switzerland

Phone: +41 (0) 56 485 60 20

Fax: +41 (0) 56 496 62 51

e-mail: [info@astrol.ch](mailto:info@astrol.ch)

web: [www.astrol.ch](http://www.astrol.ch)