

# SCHAEFER

**Series C / B 6600**

**Innovation made in Germany**



[www.schaeferpower.de](http://www.schaeferpower.de)



## DC / DC Converters, AC / DC Power Supplies &amp; Battery Chargers

- **DC Input voltage:** from 80 - 800V DC
- **AC Input voltage:** 115 / 230V AC, single phase or 200 / 400 / 480V AC, three phases
- **AC Input frequency:** 47 - 400Hz
- **Output voltage:** 5 / ... / 800V DC
- **Output current:** up to 800A
- **Output power:** 5 - 40kW

## Features

- Input / Output isolation
- Continuous short circuit protection
- Overvoltage protection
- Thermal shutdown with auto-restart
- Operational from -40 to +75 °C
- Industrial grade components
- High efficiency through ZVS topology
- High power density
- Compact and robust design
- Fan or liquid cooled

## Specifications

## Input

Voltage range	narrowing of input voltage range optimizes the efficiency (pls. specify); unit switches off at under- and overvoltage
No-load input power	30W typical
Switch-on time	<1s typical
Inrush current	3-phase AC input: limited by thermistor (except for series 55xx, 64xx, 66xx, 67xx & CW/BW56xx)
Immunity	acc. to EN 61000-6-2

## Output

DC output voltages	5   9   12   15   24   28   48 60   110   200   220   400   600   800
Output power	from 5 to 40kW
Line regulation ( $\pm 10\%$ )	0.1%
Load regulation (10-90%)	0.2%
Load transient (10-90-10%)	6 % typical
Response time to $\pm 1\%$	10 ms typical
Turn-on rise time	Soft-start, 300 ms typical
Ripple	$\leq 1\%$ + 30 mV p-p
Overload protection	current limited to 105-110% of $I_{nom}$
Overvoltage protection	OVP switches off module with automatic return to operation; after 5 seconds, the unit will remain latched off

Remote sense	standard for all series up to 150 V output, except for battery chargers; up to 10 % of $U_{nom}$ for output < 60 VDC, up to 6 V for output > 60 VDC
--------------	---

## General

Efficiency	80 - 95% typical
Operating temperature	-20 to +75 °C optional: -40 to +75 °C
Load derating	2.5%/°C above +55 °C
Storage temperature	-40 to +85 °C
Cooling	= fan cooled = liquid cooled (details see page 131)
Humidity	up to 95 % RH, non-condensing
Temperature coefficient	0.02 % / °C typical
Safety / Construction	acc. to EN 60950-1 / EN 50178
Protection category (built-in module)	IP20 acc. to EN 60529, NEMA or others upon request
EMI	acc. to EN 61000-6-4, class A, optionally class B
MTBF	approx. 70,000h @ 40 °C acc. to MIL - HDBK - 217E (notice 1)
Connectors	terminals / bolts / bars or CombTacs for Series 5100 (details see page 132)

## Options (details see page 115)

## Input

- Inrush current limiting
- Reverse polarity protection for DC input

## Output

- Decoupling diode for redundant / parallel operation
- Active current sharing for parallel operation
- Remote on / off (inhibit)
- Reducing of current limiting at high ambient temperature

## Signals

- via relay contacts
- Power ok (input)
  - DC ok (output)

## Monitoring

- of input / output voltage or current via
- analog signal
  - interface card RS232 or CAN Bus

## Programming

- of output voltage or current via
- potentiometer
- analog signal
- interface card RS232 or CAN Bus

## Programming of battery chargers

- Temperature compensated charging voltage
- Automatic / manual selection of charging characteristic

## Mechanics / environment:

- Wall mount
- Digital or analog V- and A-meter
- Increased mechanical strength
- Tropical protection
- Extended temperature range to -40 °C

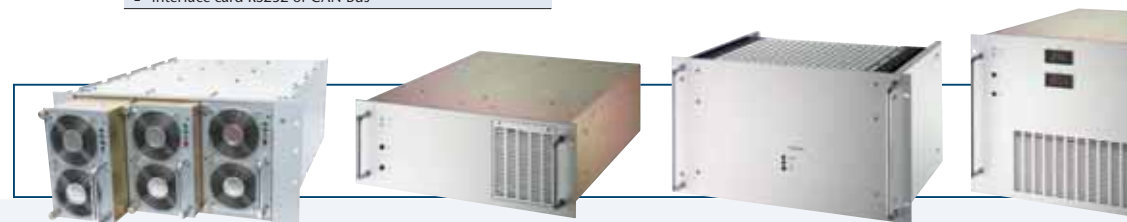



DC / DC Converters

▶ 30 KW		Output Amps	Cooling	Output VDC	
Input VDC				Adj.	Range
320–640 VDC	450–800 VDC				
C 6674 G	C 6674 K	800	☀	24	23– 26
C 6675 G	C 6675 K	800	☀	28	26– 30
C 6679 G	C 6679 K	540	☀	48	45– 55
C 6676 G	C 6676 K	440	☀	60	58– 68
C 6677 G	C 6677 K	230	☀	110	100– 130
C 6677 GJ	C 6677 KJ	150	☀	200	190– 200
C 6678 G	C 6678 K	120	☀	220	200– 250
C 6678 GJ	C 6678 KJ	75	☀	400	380– 400
C 6677 GH	C 6677 KH	50	☀	tba <sup>1)</sup>	570– 600
C 6678 GH	C 6678 KH	38	☀	tba <sup>1)</sup>	760– 800



AC / DC Power Supplies

▶ 30 KW		Output Amps	Cooling	Output VDC	
Input VAC, 3-Phase				Adj.	Range
3x400 <sup>+15%</sup> <sub>-20%</sub>	3x480 <sup>+10%</sup> <sub>-15%</sub>				
C 6684 V	C 6694 V	800	☀	24	23– 26
C 6685 V	C 6695 V	800	☀	28	26– 30
C 6689 V	C 6699 V	540	☀	48	45– 55
C 6686 V	C 6696 V	440	☀	60	58– 68
C 6687 V	C 6697 V	230	☀	110	100– 130
C 6687 VJ	C 6697 VJ	150	☀	200	190– 200
C 6688 V	C 6698 V	120	☀	220	200– 250
C 6688 VJ	C 6698 VJ	75	☀	400	380– 400
C 6687 VH	C 6697 VH	50	☀	tba <sup>1)</sup>	570– 600
C 6688 VH	C 6698 VH	38	☀	tba <sup>1)</sup>	760– 800

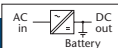

Battery Chargers

▶ 30 KW		Output Amps	Cooling	Output VDC	
Input VAC, 3-Phase				Nom. Battery Voltage	Range
3x400 <sup>+15%</sup> <sub>-20%</sub>	3x480 <sup>+10%</sup> <sub>-15%</sub>				
B 6682 V	B 6692 V	800	☀	24	24– 32
B 6684 V	B 6694 V	468	☀	48	48– 64
B 6686 V	B 6696 V	375	☀	60	60– 80
B 6687 V	B 6697 V	208	☀	110	110– 145
B 6688 V	B 6698 V	104	☀	220	220– 290

Series specific information

Input

- Hold-up time for AC input: 2.5ms typical @ nom. input voltage

General

- optional: Cooling via speed-controlled fans (depending on temperature)
- <sup>1)</sup> tba = to be advised
- ☀ = incl. fans

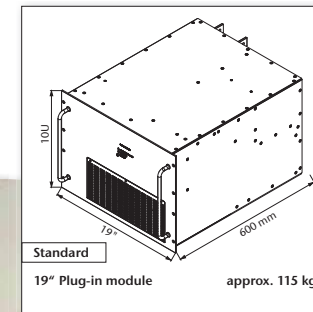

IOU



Schaefer offers the industry's most complete range of input and output voltages, combined with a selection of package style, mounting solutions, options for input and output as well as various possibilities of programming & monitoring.

**Configuration of model designation:**  
Add the designation of options to the type number of the power supply module, e.g. C 3674-w-dr-eu1.



## Input

<b>i</b>	<b>inrush current limiting</b>	<p>A thermistor is connected in series with the input lines which changes its resistance from high to low when it gets hot. It does not reduce the surge current if the input power is interrupted for a short period of time not allowing the thermistor to cool down. Thermistors are fitted as standard to all mains input models except for 1-phase input of models &gt; 2.5 kW. Thermistors are available up to 45A. For higher input current an electronic inrush current limitation can be offered.</p>	
<b>ie</b>	<b>electronic inrush current limiting</b>	<p>An electronic circuit limits the high inrush current caused by built-in capacitors. Switch-on time may increase to 5s. This is realized by a series pass transistor or depending on the input voltage by thyristor softstart.</p>	
<b>sd</b>	<b>reverse polarity protection for DC input by series diode</b>	<p>A series diode protects the module against DC input voltage of wrong polarity. However, this also causes extra losses and reduces the overall efficiency. calculation formula: <math>I_{Diode} = 2 \times P_{out\ max} / U_{in\ min}</math></p>	

<b>ad</b>	<b>reverse polarity protection for DC input by anti parallel diode</b>	<p>To avoid the power losses a diode is provided with opposite polarity in parallel to the input blowing an internal or external fuse if the module is connected to a supply of wrong polarity. calculation formula: <math>I_{Diode} = 2 \times P_{out\ max} / U_{in\ min}</math></p>	
<b>au</b>	<b>auto-ranging</b>	<p>For standard dual AC input models the range of 115 / 230 V AC is to be selected by connecting the input line to different pins on the connector. With auto-ranging the unit senses the input voltage and provides automatically the correct connection.</p>	

## Output

## Parallel / redundant operation for DC output (details see page 125/126)

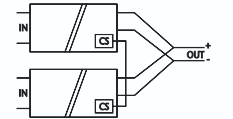
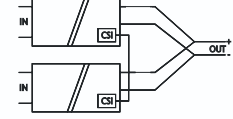
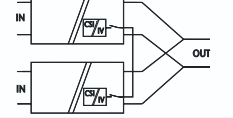
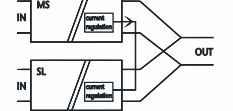
<b>dd</b>	<b>decoupling diode</b>	
	A series diode built into the units output allows paralleling of 2 or more units for redundancy or higher power or battery charging. For control purposes the anode of the diode is also available at the output connector. It cannot be loaded $\geq 0.5A$ . The sense signal is taken partially from the anode and partially from the load/cathode of the decoupling diode. This guarantees starting and operating under all conditions, but it also effects the regulation accuracy of 2%. In this way it gives a load sharing of 15-30% between the paralleled units.	
<b>cs</b>	<b>active current sharing</b>	
	An additional control circuit provides active current sharing via an interconnecting wire between converters that operate in parallel. The output lines of the converters have to be in "star point" connection.	
<b>csi</b>	<b>current sharing interrupt ("cs" included)</b>	
	"csi" will effect the removal of the "cs" signal from the load voltage common connection. Should there be an instance where a unit is not supplying the load, then the effect of its current sharing signal is removed, and the load voltage is unaffected by this condition. In terms of calibration the same criteria follow as for parallel operation.	
<b>icsi</b>	<b>current sharing interrupt ("csi" included), galvanically isolated</b>	
	The inclusion of "csi" (current sharing interrupt) and the galvanic isolation is the optimum set up for systems with high power or high currents, were the voltage drop on the power wiring could influence the cs signal.	
<b>ma</b>	<b>master / slave operation (available for series 6xxx)</b>	
	Master / Slave interface permits the parallel function of identical modules to increase the output power capacity, shared by current control without any dynamic reduction in performance.	

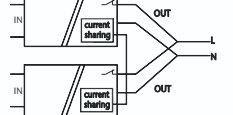

## Parallel / redundant operation for AC output

<b>red</b>	<b>inverter parallel operation: for series IT5xxx</b>	
	For redundant operation or for increased output power, two inverters of the IT5xxx series can be switched together. If one inverter fails, the internal contactor will be switched off and the output power of one inverter is still available.	

## General information

The number of options per module may be restricted due to limitation of space inside the module or due to a limited number of connector pins. Potentiometers or interface cards may be supplied separately for installation outside of the module.

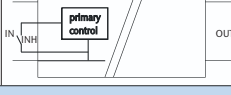
## Inhibit

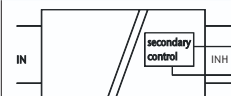
<b>h1</b>	<b>inhibit by external closing contact, signal referred to input</b>	
	The operation of the unit is inhibited when a voltage signal is applied in reference to the negative line of the input. This can also be used in combination with a thermal trip, which shuts the unit down.	
<b>h2</b>	<b>inhibit by voltage signal, signal referred to output</b>	
	Operation of the unit is inhibited if a voltage signal (5V / 10mA) is applied in reference to the negative line of the output.	
<b>h3</b>	<b>inhibit by closing contact, signal referred to output</b>	
	The operation of the unit is inhibited when a voltage signal is applied in reference to the negative line of the output. This can also be used in combination with a thermal trip, which shuts the unit down. Please note: Only relevant solution for inverters.	

## Automatic reduction of current limiting

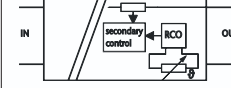
<b>rc0</b>	<b>reducing current limiting at over temperature</b>	
	A circuit reduces the current limiting level at higher temperature (to be specified). Please note: Option is available for series 48xx with ZVS topology and for high power converter modules (see page 49).	

## DC output protection

<b>rd</b>	<b>reverse polarity protection for DC output</b>	
	by reverse diode with external fuse	

## Signals

<b>pr</b>	<b>input voltage supervision (power ok) incl. relay contacts</b>	
	A logic signal is given if the input voltage (AC or DC) drops below the specified limit. In AC input models the rectified input voltage is sensed so that a power fail alarm can be avoided if at light load mains power returns before the input capacitors are substantially discharged. A relay contact is provided for failure indication.	
<b>dr</b>	<b>output voltage supervision (DC ok) incl. relay contacts</b>	
	A logic signal is given if the output voltage is below the specified limit. A relay contact is provided for failure indication. DC ok level: 5V output: 4,75V all other voltages: 90% of adjusted voltage	
<b>cf</b>	<b>charger / converter fail supervision incl. relay contacts</b>	
	A logic signal is given if the input voltage, the auxiliary voltage of the primary side and the current of the primary side exceed or go below a specified range. A relay contact is provided for failure indication.	
<b>ac</b>	<b>AC ok for inverter including relay contacts</b>	
	A logic signal is given if the output voltage of an inverter is below the specified limit. A relay contact is provided for failure indication.	

## General information

The number of options per module may be restricted due to limitation of space inside the module or due to a limited number of connector pins. Potentiometers or interface cards may be supplied separately for installation outside of the module.

## Programming

Converter Programming	
	<b>programming of output voltage from 0 to 100 %</b>
<b>eu1</b>	by external signal, 0 – 10 V
<b>eu2</b>	by external signal, 4 – 20 mA
<b>eu3</b>	by 270° potentiometer
<b>eu4</b>	by 10 turn potentiometer
	<b>programming of output current from 0 to 100 %</b>
<b>ei1</b>	by external signal, 0 – 10 V
<b>ei2</b>	by external signal, 4 – 20 mA
<b>ei3</b>	by 270° potentiometer
<b>ei4</b>	by 10 turn potentiometer
<b>iso</b>	<b>isolating amplifier for programming</b>
	Programming signal is galvanically isolated from any potentials of the power supply.
	<b>programming via</b>
<b>rs</b>	RS232 (external)
<b>can</b>	CAN Bus (external)

Charger Programming	
	<b>temperature features</b>
<b>tc</b>	temperature compensated charging voltage (sensor not included)
<b>ts1</b>	temperature sensor not interchangeable due to fixed resistor values
<b>ts2</b>	temperature sensor interchangeable, IC controlled
	<b>charging characteristics</b>
<b>ch1</b>	External card: automatic and manual selection of charging characteristic (float/ equalized boost charge) with timer (delayed return to normal operation), including aux. supply and options "tc" and "ts1"
<b>ch2</b>	External card: consisting of option "ch1" plus: Battery current limitation & battery shunt
<b>ch3</b>	External card: consisting of option "ch2" plus: CAN-Bus-interface & programmable parameters

## Monitoring

Converter / Charger Monitoring	
	<b>monitoring of output voltage from 0 to 100 %</b>
<b>mu1</b>	by external signal, 0 – 10 V
<b>mu2</b>	by external signal, 4 – 20 mA
	<b>monitoring of output current from 0 to 100 %</b>
<b>mi1</b>	by external signal, 0 – 10 V
<b>mi2</b>	by external signal, 4 – 20 mA
<b>iso</b>	<b>isolating amplifier for monitoring</b>
	Monitoring signal is galvanically isolated from any potentials of the power supply.
	<b>monitoring via</b>
<b>rs</b>	RS232 (external)
<b>can</b>	CAN Bus (external)

## Mechanics

As standard, all of the modules are designed and manufactured for insertion into 19" sub-racks. Higher power modules are already constructed in 19" format.

Optionally, 19" sub-racks are available and can be configured as 3U or 6U allowing any mix of units and can be upgraded in accordance to the customers' requirements, e.g.

- mating connectors wired to a terminal block
- fuses or circuit breakers
- hot swappable configuration upon request
- analog or digital meters
- switches
- fans
- filters
- decoupling diodes
- provisions for keying the modules to ensure module / slot designation



### 19" Sub-Racks

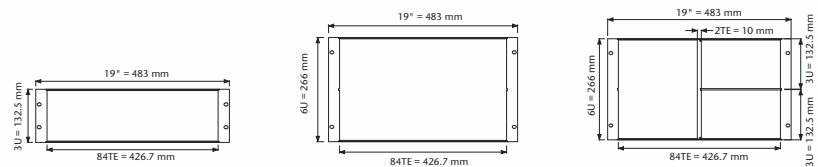

#### w wall mount

Modules, which have the wall mount option, are typically fixed to a structure or within a cabinet. Depending on the size of the module, this may be done with a flat or angled plate (see photo). The load connections are typically through a terminal block. Should the application not require a pluggable module / rack solution, wall mounting presents an alternative option for the customer to choose from.



#### cha chassis mount

Module is designed for installation to a structure or within a cabinet. Screw type mating connectors are supplied with the module. Due to the limited number of connector pins this option is not available for modules with dual AC input. Option is available for currents up to 60Amps.

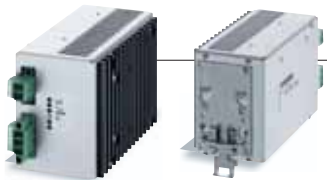

#### din DIN rail mount

Module is designed for DIN rail mounting to a structure or within a cabinet. Screw type mating connectors are supplied with the module. Due to the limited number of connector pins this option is not available for modules with dual AC input. Option is available for currents up to 60Amps.

## Environment

### t tropical protection

The unit is given additional protection by a heavy coat of varnish on the printed circuit board(s) and on components to achieve 99% RH, non condensing.

### c extended temperature range

The circuit is designed and tested for operation at an ambient temperature as low as  $-40^{\circ}\text{C}$ .

### ms increased mechanical strength

Screws are secured with Loctite and heavy components are fastened by ties and / or glue. Modules with the „ms“ are build acc. to EN 61373 regarding shock and vibration.



## Control &amp; Monitoring

**TC 01 Control function**

analogue or micro-processor-controlled supervision:

- input voltage
- output voltage
- battery circuit
- ground insulation failure
- over temperature

**UC 03 Enhanced controller function**

The „UC 03“ unit controls and supervises the optimum charging of a battery, up to an entire UPS system. A battery charging in a basic way, with a switch mode AC / DC or DC / DC Charger, is shown in the following figure.

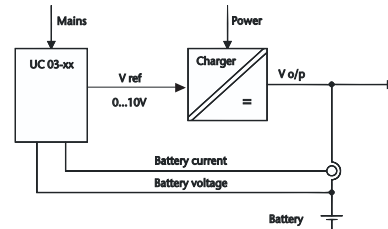

The charger output voltage is regulated inside the charger according to the input "Vref" signal. The gain factor between Vref and Vo/p is defined in the Specification of the Charger. The charger current limitation is also a function of the charger. The reference values, limitations and monitoring levels for charging a battery (ies) are configurable in the UC 03. The charging of the battery occurs according to the current / voltage characteristics, i.e. the battery is loaded in current limitation, until the appropriate voltage is reached. The following working conditions are processed by the UC 03:

- a. Float Charge conforms to the recommended permanent voltage to hold the battery within a completely charged state.
- b. Equalize or Automatic Boost Charge: To charge the battery after a partial or deep discharge as quickly as possible, an increased voltage is provided. This mode is activated automatically via different functions, or manually via the front panel button.
- c. Manual Boost Charge: independently adjustable voltage, to regenerate an aged battery. In all three working conditions the maximum battery charge current is limited.





The following technical notes contain important information about various operating possibilities and circuitries as well as instructions that should be followed during installation etc. For further information please contact the SCHAEFER Team.

Parallel / Redundant System	I25
AC or DC input	I27
DC output	I28
AC output	I29
DC output voltage stabilization	I30
Mounting & Installation	I31
Connectors	I32
Basic Topologies	I33



### Parallel / Redundant System

#### Parallel operation

Single output modules of the same voltage / power rating can operate in parallel under specific conditions. The output voltage can be carefully adjusted to be near identical. When there is sufficient loading on the combined output, all units will be active and supply the load. The load demand must be significant enough for the multiple units to deliver output current.

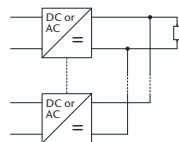

#### Redundant operation

The inclusion of the option "dd" (decoupling diode) on the output of the units will permit parallel operation, where the inability to provide output from one unit will not have a negative effect on the load provision. The decoupling diode will also result in a load regulation value, which, as a percentage of the output voltage, will be unit / output dependent. In terms of calibration the same criteria follow as for parallel operation.

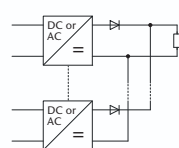

#### Balanced current operation

The inclusion of the option "cs" (current sharing) allows for parallel operation with a significant degree of current balancing. The communication between the units allows for a voltage setting correction, which in turn shall equate to an automatic current sharing (balancing) on the outputs. The tolerance of such balancing is module dependent. In terms of calibration the same criteria follow as for parallel operation.

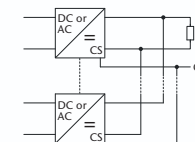

#### Redundant balanced operation

The inclusion of both, the "cs" and "dd" option results in an optimized balanced current provision while being de-coupled from each other. A connected module, who is not supplying an output voltage, will influence the load voltage. The voltage may be reduced by up to 7%. In terms of calibration the same criteria follow as for parallel operation.

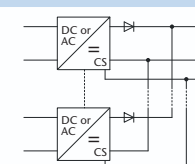

#### Fault tolerant operation

The inclusion of "csi" (current sharing interrupt), "cs" and "dd" is the optimum set up for a fault tolerant application. "csi" will effect the removal of the "cs" signal from the load voltage common connection. Should there be an instance where a unit is not supplying the load, then the effect of its current sharing signal is removed, and the load voltage is unaffected by this condition. In terms of calibration the same criteria follow as for parallel operation.

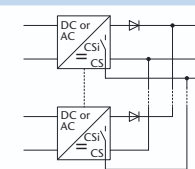

AC or DC input

<b>Inrush current</b>	When the module is connected to the input power, the primary capacitors will be charged by a high current pulse. The magnitude of this pulse depends mainly on the input supply system. With a thermistor (temperature dependent resistor) in series with the input, this current pulse can be reduced, as the thermistor has a relatively high value of resistance as long as it is cold. This resistance becomes very low as the thermistor heats up. If the input power is interrupted for a short period of time not allowing the thermistor to cool down, and the primary capacitors are discharged, the current limitation function of the thermistor will not be effective. The thermistor is standard on mains input models up to 45 Amps input current. For higher input current there are two further alternatives available: Schaefer PFC or an electronic current limitation.
<b>Power factor correction (PFC)</b>	Power supplies draw line current in pulses from the input supply. Should it be required, a PFC will integrate these pulses to be both, effectively sinusoidal in shape, and in phase with the AC input supply. The result of this integration, be it active or passive, is the reduction of the harmonic distortion and allows a more effective loading of the input source.
<b>Spike suppression</b>	High input voltage spikes generated in the supply system that could disturb operation of the unit or cause damage will be absorbed by a varistor across the input lines.
<b>Input under and over voltage turn off</b>	The input voltage range of the unit is defined as the voltage limits at which it will operate. Should the input be reduced to a specific voltage, the unit will turn off by switching off the power circuit. The same applies to an increase in the input voltage. Once a preset value is reached then the power circuit will be switched off. It must be considered that the switching off of the power circuit does not mean a removal of the input circuit from the power supply.
<b>Thermal shutdown with auto restart</b>	The higher power Schaefer modules are fitted with a thermal shutdown. In the event of a temperature rise above a preset value, the unit will turn off. This safety feature will then remain active until the point of temperature measurement has reduced significantly. The time duration for this to be reached is dependent upon the environment and level of cooling.
<b>Temperature derated load</b>	It is the responsibility of the client to reduce the loading of the Schaefer product with respect to the temperature (derated load: 2.5 % / °C from +55 °C operating temperature). The maximum operating temperature of +75 °C must lead to the unit being switched off.
<b>Efficiency</b>	The optimum efficiency is obtained through a high input voltage measured against a high output voltage at maximum power rating.

DC output

<b>Soft start</b>	The application of the input power permits the unit to generate a secondary output. The switching on of the primary power circuit is controlled and gradually increased to allow a controlled charging of the secondary capacitors. The time duration for the secondary capacitors to be charged is defined as the soft start.																										
<b>No load operation</b>	Single output converters require no minimum load for operation within tolerance. Multi output converters require the main output be loaded. Semi-regulated auxiliary outputs may also require a minimum load to be applied.																										
<b>Short circuit protection</b>	The main output of a converter will be immune against a momentary or continuous short circuit. The secondary current limitation will not permit the sustained output current to be higher than the calibrated setting, and it will actively reduce the output voltage in accordance to the overload. The removal of the overload / short circuit will result in the output voltage being increased to the calibrated value. Regulated auxiliary outputs will also reduce the output voltage / current in accordance to their overloading. The characteristic may vary according to the circuit employed.																										
<b>Over voltage protection (OVP)</b>	The main output voltage is measured, either internally or through sense leads. This measured value is compared against a calibrated value. When the calibrated value has been reached, this circuit turns off the primary power circuit. Once the measured value has reduced below the calibrated value, the primary power circuit is permitted, once again, to be activated. The high power units have an additional feature, which will shut down the primary power circuit after a continued OVP operation. The input power must be re-cycled in order to remove the unit from shut down.																										
<table border="1"> <tr> <td>voltage adjustment [V]</td> <td>5</td> <td>9</td> <td>12</td> <td>15</td> <td>24</td> <td>28</td> <td>48</td> <td>60</td> <td>110</td> <td>200</td> <td>220</td> <td>400</td> </tr> <tr> <td>Over voltage protection [V]</td> <td>6.5</td> <td>12</td> <td>15</td> <td>18</td> <td>30</td> <td>35</td> <td>60</td> <td>70</td> <td>140</td> <td>220</td> <td>280</td> <td>440</td> </tr> </table>		voltage adjustment [V]	5	9	12	15	24	28	48	60	110	200	220	400	Over voltage protection [V]	6.5	12	15	18	30	35	60	70	140	220	280	440
voltage adjustment [V]	5	9	12	15	24	28	48	60	110	200	220	400															
Over voltage protection [V]	6.5	12	15	18	30	35	60	70	140	220	280	440															
<b>Sense leads</b>	Through the use of sense leads, an output voltage may be regulated to a point outside of the unit. The sense leads should be connected to the power connection at the point of load under regard of polarity. There should be a non-interruptible connection between sense and load points. Interruption may lead to damage or the activation of the OVP circuit. The units, which have sense leads, have the ability to regulate to a higher voltage at the output connection. This increase is largely dependent upon the unit. The details may be found in the respective unit specification. Parallel operation with sense leads allows a common point for the units to regulate their voltages to. Units whose output voltage has been calibrated to be near identical will now be able to supply a common load. De-coupled outputs will be sensed both, before and after the decoupling diodes, which in turn will lead to an output voltage regulation, specific to load and unit. Sense leads are typically employed with a decoupled output voltage of less than 40 VDC. The current sharing option will effectively override the sense lead output voltage setting, but the point at which the output voltage is regulated, will be the point of sense lead connection.																										

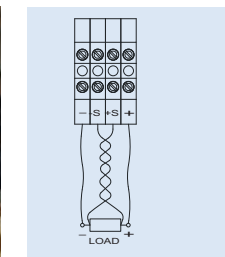

AC output

<b>Soft start</b>	
The application of the input power permits the unit to generate an AC output. The output power increases linearly until it reaches its calibrated value. This delay from initial	output generation until the nominal value is defined as the soft start.
<b>No load operation</b>	
Inverters require no minimum load for operation within tolerance.	
<b>Short circuit protection</b>	
The inverter current limitation circuit provides a protection against an external short circuit. Due to the need for crest factor and pulse power requirement in many applications, the current limitation permits twice the nominal output current to be extracted for up to 1 second. The current limitation	will then be reduced to typically 105% of the nominal value. Should the overloading persist, and the output voltage reduce to less than 20% of nominal, then the unit will perceive an overload condition and turn off. Recycling the input voltage will remove this latched off condition.
<b>Crest factor</b>	
The ability of an inverter to deliver to a load an inrush current is related to the crest factor. The crest factor is the ratio	between the nominal and the peak current.
<b>Over voltage protection (OVP)</b>	
The high power units have this feature. It will shut down the primary power circuit after a continued OVP operation. The input power must be re-cycled in order to remove the unit from shut down. The output voltage is measured internally. This measured value is compared against a reference value.	When the reference value has been reached, this circuit turns off the power circuit. Once the measured value has reduced below the reference value the power circuit is once again permitted to be activated.
<b>Sense leads</b>	
Sense leads are internally connected in all standard configurations.	
<b>Harmonic distortion</b>	
The generated inverter output is designed to follow a true sine wave signal. Deviation from this sine wave is measured as distortion. The level of deviation is defined as harmonic	distortion. The total harmonic distortion THD is the relationship between the harmonic and fundamental wave forms.
<b>Surge power</b>	
The AC output may facilitate the output load through its ability to provide more than the nominal current for up to 1	second.
<b>Power factor</b>	
The AC output may facilitate complex or other loads, through its ability to provide a phase shifted output current at nominal power rating. This is once again due to the ability to provide	more than the nominal output current for a limited period of time.

DC output voltage stabilization

The output voltage of a battery charger with parallel connected batteries varies substantially with the charging condition of the battery. For many applications, however, the load circuit requires a more stabilized voltage which can be accomplished by:

**Voltage dropping diodes**

being interconnected between battery and load, reduce the voltage to a value suitable for the load. They are short-circuited by one or more contactors only if a partial reduction or no voltage reduction is required. A control circuit senses the battery voltage and energizes the contactors. Voltage dropping diodes cause substantial power losses as the excess voltage is absorbed by the diodes. However, due to simplicity, this method is frequently used, especially if the voltage reduction is needed only during the short periods of high-rate charging.

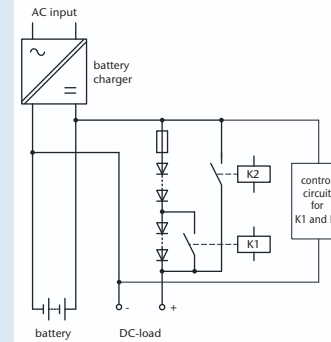

**Switchmode step-up converters**

are DC/DC converters supplied from the battery with the output connected in series to the battery. They present a very economical solution as they only add voltage when the battery is discharged. *Details see page 47/ 83.*

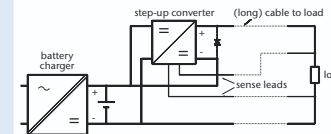

Mounting

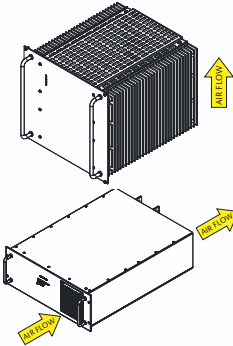
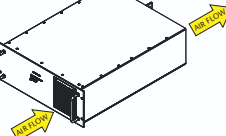
<p><b>Air flow</b></p> <p>Airflow to the power supply is preferred to be filtered, below 55 °C, an airflow resistivity (pressure drop) of below 20kPa and is required to comply with the EN60950 pollution category II. Diffused thermal energy is required to be exhausted and displaced by air as detailed above. Thermal management is required where the air provided to a power supply complies with the power supply's design parameters. The use of fans requires the increase airflow rate to a minimum of 120m<sup>3</sup>/h (corresponding to 70 cfm). The airflow resistivity and respective pressure drop should be considered when the fan is required.</p>	
<p><b>Direction of air flow</b></p> <p>Typically, Schaefer Modules and systems are cooled through air supply entering below and exiting above, with the exception of models of series C/B 5100, 5200, 5300, 5400, 6400 and 6600 whose airflow is from front to back.</p> <p>Custom design also offers lateral cooling. Such details are however, project specific.</p>	
<p><b>Cabinet</b></p> <p>To enhance a module / system, a cabinet may be employed.</p> <ul style="list-style-type: none"> <li>- This may be required to fulfil the increased IP / NEMA rating, due to a negative effect of the environment on the solution.</li> <li>- Specifically, in an unclean, saturated, corrosive or otherwise aggressive air quality it may be required to employ a cabinet in combination with features such as hermetical closure and air exchange amongst others.</li> <li>- The enclosure must be capable of sustaining the weight of the modules, specifically if module support rails are used.</li> <li>- Stationary cabinets should be fastened to the ground.</li> <li>- The centre of gravity must be as low as possible with portable systems.</li> </ul>	
<p><b>Transportation of module</b></p> <p>The grips on the front of the modules are to assist in module insertion into a sub-rack, and not for supporting the weight of the module.</p>	
<p><b>Wall mount / chassis mount</b></p> <p>Modules with a mounting plate or angle are designed for integration into the host equipment. They are not for employment outside of an enclosure.</p>	

Installation

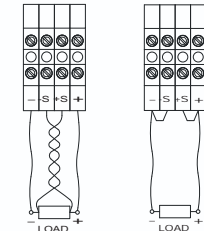
<p><b>Input fuse</b></p> <p>An input fuse, internal or external, should be selected with a slow burn characteristic.</p>	
<p><b>Sense leads</b></p> <ul style="list-style-type: none"> <li>- The distance between the load connection and the module / system may result in a voltage drop between the output and the load connection. To compensate for a limited value of such a voltage drop, sense leads can be connected to the load under regard of polarity. The sense leads determine the point to which the voltage regulates. As the sense leads carry very low current, they are susceptible to noise pick up. Therefore, it is recommended that they are intertwined and if necessary shielded.</li> <li>- When the remote sense facility is not used, sense links must be made at the output terminals. If the sense links are left open, the output voltage may rise causing the OVP circuit to be activated.</li> </ul>	

Connectors

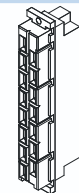
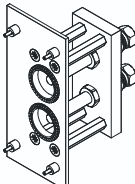
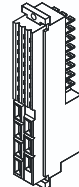
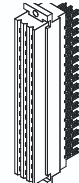
<p><b>H15 Female Connector</b></p> <p>Number of contacts: 15              Contacts: Fastons or screw terminals              Operating current at +20 °C: 15 A              Operating temperature: -55 to +125 °C              Test voltage (contact to contact): 3100 V<sub>rms</sub>              Test voltage (contact to ground): 3100 V<sub>rms</sub>              Contact resistance: 8 mΩ              Performance according to: IEC 60603-2 / DIN 41612</p>	
<p><b>High Current Female Connector</b></p> <p>Number of contacts: 2              Contacts: Bolts with 8 mm diameter for terminal lugs M8              Operating current at +20 °C: 170 A              Operating temperature: -55 to +125 °C              Test voltage (contact to contact): 500 V<sub>rms</sub>              Test voltage (contact to ground): 2500 V<sub>rms</sub>              Contact resistance: 0.06 mΩ              Dimensions (H x W x D): 118 x 35 x 85 mm              Performance according to: IEC 60603-2 / DIN 41612</p>	
<p><b>F24H7 Female Connector</b></p> <p>Number of contacts: 24 / 7              Contacts: solder pins / fastons              Operating current at +20 °C: 6 / 15 A              Operating temperature: -55 to +125 °C              Test voltage (contact to contact): 1550 / 3100 Vrms              Test voltage (contact to ground): 2500 / 3100 Vrms              Contact resistance: 15 / 8 mΩ              Performance according to: IEC 60603-2 / DIN 41612</p>	
<p><b>F48 Female Connector</b></p> <p>Number of contacts: 48              Contacts: solder pins              Operating current at +20 °C: 6 A              Operating temperature: -55 to +125 °C              Test voltage (contact to contact): 1550 V<sub>rms</sub>              Test voltage (contact to ground): 2500 V<sub>rms</sub>              Contact resistance: 15 mΩ              Performance according to: IEC 60603-2 / DIN 41612</p>	



There are various circuit topologies and the selection depends on the requirements, such as low or high input voltage, low or high output voltage, single or multi output, power rating. The following circuits present our common concepts of power conversion.

**Push Pull Converter**

The push pull converter is often used for applications with low input voltage. The switching transistors are alternately conducting with variable pulse-width. At the secondary side, after rectification and filtering, the output voltage is sensed and compared with a reference. The error signal controls via an opto-coupler the primary circuit.

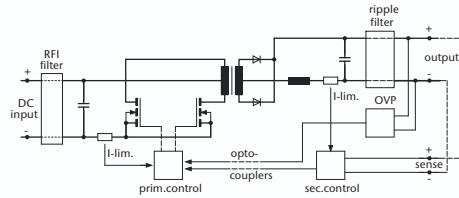

**Half Bridge Converter**

The following circuit shows, as an example, a converter with dual AC input in a half bridge connection. With the input voltage supplied to the 230 V terminal, the rectifier circuit is a standard bridge connection; supplied to the 115 V terminal the rectifier circuit functions as a voltage doubler circuit.

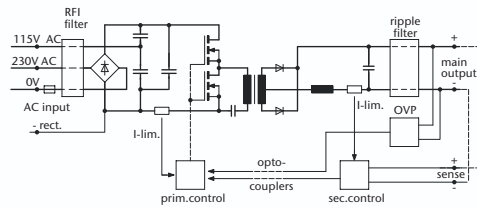

**DC/AC Inverter**

The diagram beside shows the circuit of an inverter. The DC input voltage is transformed by the power transistors T1-T4 with the parallel connected inverse diodes D1-D4 in a pulse-width modulated square wave voltage. The choke with the windings LI and LII integrates this voltage, and at the capacitor C a sinusoidal output voltage is available. The power transistors are controlled via opto-coupler in such a way that not both transistors of one branch are conducting at the same time. The output voltage is sensed and compared with a reference signal generating the firing pulses for the power transistors. The output current is measured via shunt R1 and limited through the control circuit. Isolation between input and output and voltage transformation can either be provided by a converter connected to the input of an inverter or by a transformer connected to the output of an inverter.

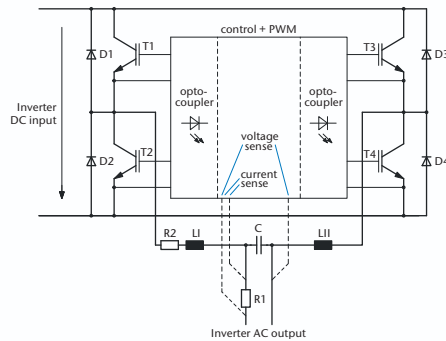

**Full Bridge Converter with Zero Voltage Switching (ZVS)**

For the higher power modules presented from page 46 to 67 the primary circuit is performed as a full bridge connection with four switching transistors (IGBTs) being controlled by the driver and protective circuits. The special mode of driving the IGBTs in conjunction with the resonant choke and the symmetrical capacitor allows for "zero voltage switching" which improves the efficiency and reduces the switching noise. The input can be designed for both, DC or AC. At the secondary side of the transformer the voltage is rectified and filtered. Then the output voltage is sensed and compared with a reference, and

the error signal controls via opto-coupler the switching transistors on the primary side. For over voltage protection the OVP circuit senses the output voltage and turns off the switching transistors if a certain level is reached. The circuit automatically returns to operation but is repeatedly switched off and turned on again if the over voltage condition is still present. If the unit does not return to normal operation within a short period of time, it will then be switched off. For current limiting the signal sensed by the LEM transformer starts to reduce the output voltage if the current exceeds a certain limit.

